



Pins and Badges

A popular accessory across different cultures throughout the world.





Gold Round Rope Design Metal Badges. **Backside Options** : Pin, Butterfly Clutch or Magnet. **Product Size** : Available in 5 different sizes. **Printing Options** : Digital Printing with Epoxy

2044-G	13 mm Metal Badge
2045-G	22 mm Metal Badge
2046-G	27 mm Metal Badge
2047-G	37 mm Metal Badge
2048-G	47 mm Metal Badge

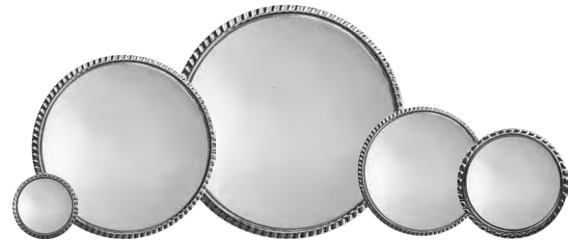

Silver Round Rope Design Metal Badges. **Backside Options** : Pin, Butterfly Clutch or Magnet. **Product Size** : Available in 5 different sizes. **Printing Options** : Digital Printing with Epoxy

2044-S	13 mm Metal Badge
2045-S	22 mm Metal Badge
2046-S	27 mm Metal Badge
2047-S	37 mm Metal Badge
2048-S	47 mm Metal Badge



Bronze Round Rope Design Metal Badges. **Backside Options** : Pin, Butterfly Clutch or Magnet. **Product Size** : Available in 3 different sizes. **Printing Options** : Digital Printing with Epoxy

2044-B	13 mm Metal Badge
2046-B	27 mm Metal Badge
2047-B	37 mm Metal Badge



Gold Oval Rope Design Metal Badges. **Backside Options** : Pin, Butterfly Clutch or Magnet. **Product Size** : Available in 4 different sizes. **Printing Options** : Digital Printing with Epoxy

2040-G	22 x 15 mm Metal Badge
2041-G	28 x 20 mm Metal Badge
2042-G	37 x 26 mm Metal Badge
2043-G	47 x 31 mm Metal Badge

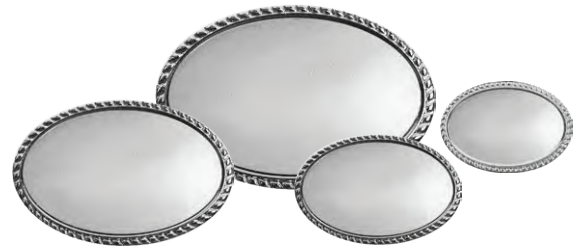

Silver Oval Rope Design Metal Badges. **Backside Options** : Pin, Butterfly Clutch or Magnet. **Product Size** : Available in 4 different sizes. **Printing Options** : Digital Printing with Epoxy

2040-N	22 x 15 mm Metal Badge
2041-N	28 x 20 mm Metal Badge
2042-N	37 x 26 mm Metal Badge
2043-N	47 x 31 mm Metal Badge



Bronze Oval Rope Design Metal Badges. **Backside Options** : Pin, Butterfly Clutch or Magnet. **Product Size** : Available in 4 different sizes. **Printing Options** : Digital Printing with Epoxy

2040-B	22 x 15 mm Metal Badge
2041-B	28 x 20 mm Metal Badge
2042-B	37 x 26 mm Metal Badge
2043-B	47 x 31 mm Metal Badge



Gold Round Flower Design Metal Badges. **Backside Options** : Pin, Butterfly Clutch or Magnet. **Product Size** : Available in 3 different sizes. **Printing Options** : Digital Printing with Epoxy

2037-G	20 mm Metal Badge
2038-G	25 mm Metal Badge
2039-G	35 mm Metal Badge



Silver Round Flower Design Metal Badges. **Backside Options** : Pin, Butterfly Clutch or Magnet. **Product Size** : Available in 3 different sizes. **Printing Options** : Digital Printing with Epoxy

2037-N	20 mm Metal Badge
2038-N	25 mm Metal Badge
2039-N	35 mm Metal Badge



Bronze Round Flower Design Metal Badges. **Backside Options** : Pin, Butterfly Clutch or Magnet. **Product Size** : Available in 3 different sizes. **Printing Options** : Digital Printing with Epoxy

2037-B	13 mm Metal Badge
2038-B	27 mm Metal Badge
2039-B	37 mm Metal Badge

Flat Oval Design Metal Badge



optional backside : Pin, Butterfly Clutch or Magnet

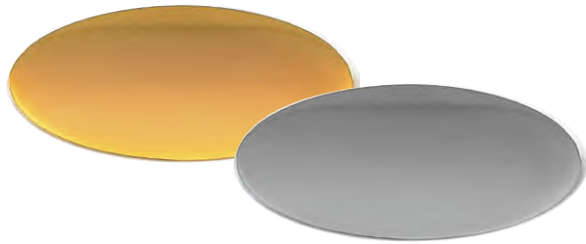

2029

Flat Oval Metal Badges. **Backside Options :** Pin, Butterfly Clutch or Magnet. **Product Size :** 45 x 20 mm. **Printing Options :** Digital Printing with Epoxy. Laser Markings.

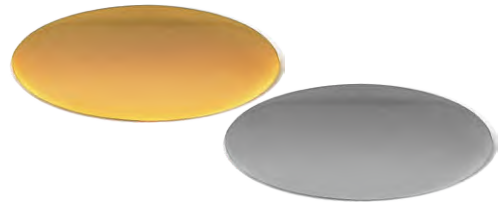

2028

Flat Oval Metal Badges. **Backside Options :** Pin, Butterfly Clutch or Magnet. **Product Size :** 35 x 15 mm. **Printing Options :** Digital Printing with Epoxy

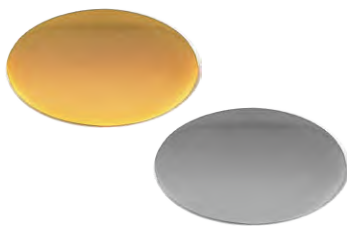

2027

Flat Oval Metal Badges. **Backside Options :** Pin, Butterfly Clutch or Magnet. **Product Size :** 25 x 15 mm. **Printing Options :** Digital Printing with Epoxy

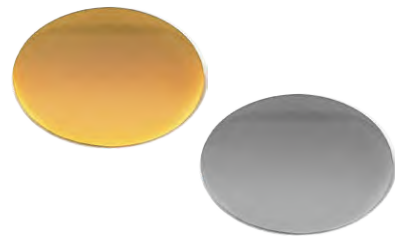

2033

Flat Oval Metal Badges. **Backside Options :** Pin, Butterfly Clutch or Magnet. **Product Size :** 25 x 18 mm. **Printing Options :** Digital Printing with Epoxy

Flat Round Design Metal Badge



optional backside : Pin, Butterfly Clutch or Magnet



2026-SS

Product Size :
35 mm.



2083-SS

Product Size :
30 mm.



2025-N

Product Size :
25 mm.



2024-N

Product Size :
20 mm.



2034-N

Product Size :
15 mm.



2026-G

Product Size :
35 mm.



2083-G

Product Size :
30 mm.



2025-G

Product Size :
25 mm.



2024-G

Product Size :
20 mm.



2034-G

Product Size :
15 mm.

Flat Rectangular Metal Badge



optional backside : Pin, Butterfly Clutch or Magnet



2030-22G



2030-22N



2030-18G



2030-18N

Flat Square Metal Badges. **Backside Options :** Pin, Butterfly Clutch or Magnet. **Product Size :** 22 x 22 mm. **Printing Options :** Digital Printing with Epoxy

Flat Square Metal Badges. **Backside Options :** Pin, Butterfly Clutch or Magnet. **Product Size :** 18 x 18 mm. **Printing Options :** Digital Printing with Epoxy



Magnet



Butterfly Clutch

LP-101N30

Round Shaped Black Metal Badges. Optional Backside attachment. **Product Size :** 30 mm (dia). **Printing Options :** Digital Printing with Epoxy



Magnet



Butterfly Clutch

2115

Round Shaped Gold Metal Badges. Optional Backside attachment. **Product Size :** 20 mm (dia). **Printing Options :** Digital Printing with Epoxy



2106 : Magnet



2106-G : Butterfly Clutch

2106

Heart Metal Badges. Optional Backside attachment. **Product Size :** 30 x 32 mm. **Printing Options :** Digital Printing with Epoxy



G



N

2082

I Love Design Metal Badges. Backside with Butterfly Clutch. **Product Size :** 20 x 30 mm. **Printing Options :** Digital Printing with Epoxy



2094

Flag with Round Metal Badges. Optional Backside butterfly clutch or magnet attachment. **Product Size** : 25 x 35 mm. **Printing Options** : Digital Printing with Epoxy



2094-G-UAE

UAE Flag with Round Metal Badges. Optional Backside butterfly clutch or magnet attachment. **Product Size** : 25 x 35 mm. **Printing Options** : Digital Printing with Epoxy



2053-N

Square shaped with curved corner Metal Badges. Backside with Butterfly Clutch. **Product Size** : 25 x 25 mm. **Printing Options** : Digital Printing with Epoxy



2049

Arched Shaped Metal Badges. Backside with Butterfly Clutch. **Product Size** : 30 x 30 mm. **Printing Options** : Digital Printing with Epoxy



2092 : Butterfly Clutch

2092-WM : Magnet

2092

Flag Metal Badges. Backside with Butterfly Clutch. **Product Size** : 20 x 15 mm. **Printing Options** : Digital Printing with Epoxy



2091

Flag Metal Badges. Backside with Butterfly Clutch. **Product Size** : 20 x 15 mm. **Printing Options** : Digital Printing with Epoxy



* Optional Flag Designs *

2081

Two-Flag Metal Badges. Backside with Butterfly Clutch. **Product Size** : 35 x 25 mm. **Printing Options** : Digital Printing with Epoxy



2031

Rectangular Shaped Metal Badges. Backside with Butterfly Clutch. **Product Size** : 30 x 17 mm. **Printing Options** : Digital Printing with Epoxy

Ready Made Badges



NDB-21

UAE Flag Metal Badge. Debossed design with colour filling. Backside magnet attachment. **Product Size** : 35 x 20 mm.



NDB-19-W

UAE National Brand Metal Badge. Debossed design with colour filling. Backside magnet attachment. **Product Size** : 39 x 29 mm.



2101

Dubai Metal Badge. Debossed design with colour filling. Backside magnet attachment. **Product Size** : 50 x 21 mm.



2115-GR

Gold Metal Badge with enamel green round design. Backside gold magnet attachment. **Product Size** : 19 mm (dia).



LP-FLN40-KSA

KSA Flag Metal Badge. Debossed design with colour filling. Backside magnet attachment. **Product Size** : 40 x 20 mm.



LP-FWM10-KSA

KSA Flag Metal Badge. Debossed design with colour filling. Backside magnet attachment. **Product Size** : 20 x 17 mm.



LP-BCP15 : Butterfly Clutch

LP-BC20 : Magnet

Pink Ribbon Metal Badge. Debossed design with colour filling. **Product Size** : (LP-BCP15) 15 x 30 mm, (LP-BCM20) 20 x 40 mm.



2114 : Magnet

2114-WP : Butterfly Clutch

Smiley Design Metal Badge. Debossed design with colour filling. Optional Backside attachment. **Product Size** : 30 mm

Ready Made Badges



NDB-16

UAE Flag Metal Badge. Debossed design with colour filling. Backside magnet attachment. **Product Size** : 30 x 30 mm.



NDB-17

UAE Flag Metal Badge. Debossed design with colour filling. Backside magnet attachment. **Product Size** : 40 x 30 mm.



NDB-18

UAE Flag Ribbon Metal Badges. Debossed design with colour filling. Backside magnet attachment. **Product Size** : 28 x 45 mm.



2102

UAE Peace Sign Metal Badge. Debossed design with colour filling. Backside magnet attachment. **Product Size** : 28 x 35 mm.

Promotional Lapel Pins

It has been a popular accessory for many years, worn by people from all walks of life.

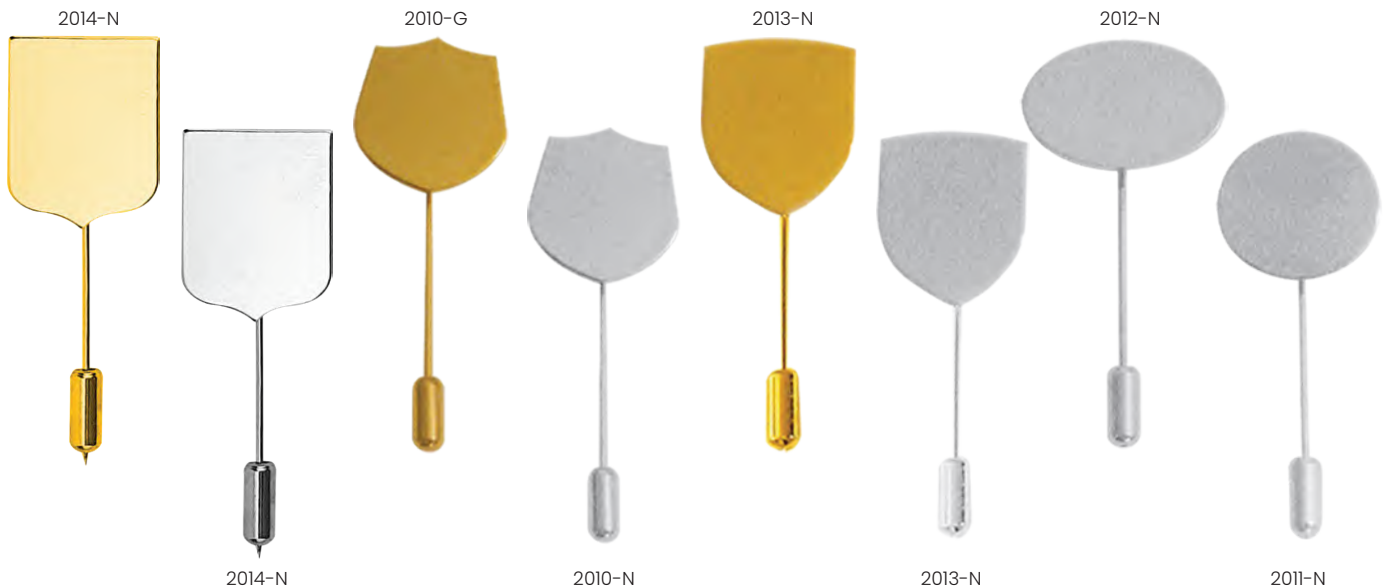
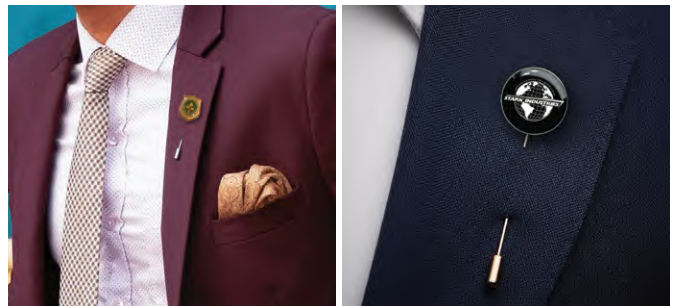



Medals

In today's society, the concept of medals holds great significance and value. Medals are physical symbols of achievement and recognition.



2065

Promotional Medal. Available in Gold/Silver/Bronze. Optional Ribbon. **Product Size** : 65 mm, **Printing Options** : Digital Printing with Epoxy.



2065-G

2065-N

2065-B



2064

Promotional Medal. Available in Gold/Silver/Bronze. Optional Ribbon. **Product Size** : 50 mm, **Printing Options** : Digital Printing with Epoxy.



2065-G

2065-N

2065-B

Optional Medal Ribbons



2065R-UAE

2065R-KSA

2065R-OM

2065R-BH

2065R-QT



2067

Fantastic alternative option to traditional medals, glass medals can be printed in full color or laser engraving. Elevate your medal award to your award winners.

Product Size : 12 mm (dia). 2.8mm thickness.
Printing Options : Laser Engraving, UV Printing.



2080

Gold plated Flag and Medal Metal Badge. Backside with Pin attachment. **Product Size :** Top Area : 45 x 25 mm. Round Area : 42 mm (dia). **Printing Options :** Digital Printing with Epoxy.



2084-N

Silver Plated Pin Medal. Backside with Pin attachment. **Product Size :** Top Area : 50 x 15 mm. Round Area : 55 mm (dia). **Printing Options :** Digital Printing with Epoxy.



2055

Medal Pin Badges. Backside with Pin attachment. **Product Size :** 45 mm (dia). **Printing Options :** Digital Printing with Epoxy.

Custom Made Medals



We are constantly creating new ideas that combines your design with metal medals, blend in with little masterpieces. The precisely developed design makes customers be amazed with the output of our medals. Promoting your logo in full colour.

You can also choose from our pre-made basic cut medals.

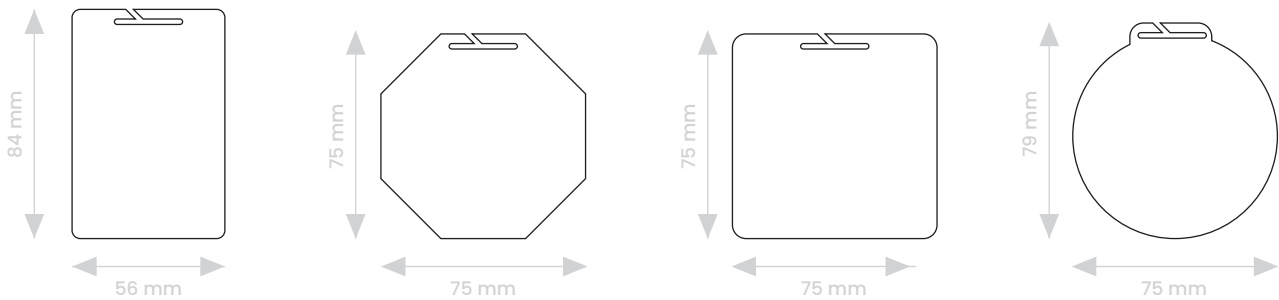

We have also offer a combination of metal & acrylic medals

